

viccarbe

Burin

Designed by Patricia Urquiola

Technical info - Outdoor

HEIGHT 74 | 29³/₄"

BUD60CNEX
table round 60 | 23⁵/₈"

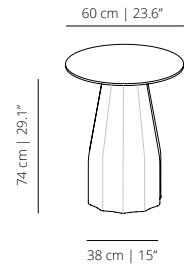

HEIGHT 74 | 29³/₄"

BUD80CNEX
table round 80 | 31¹/₂"

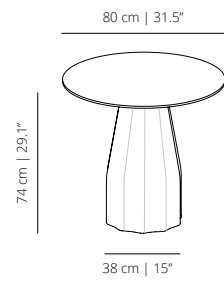

HEIGHT 74 | 29³/₄"

BUD120CNEX
table round 120 | 47¹/₄"

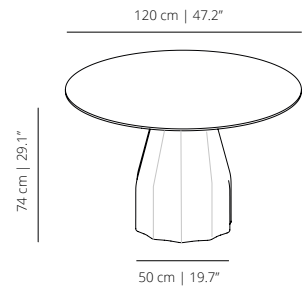

BUD70CNEX
table round 70 | 27⁶/₁₆"

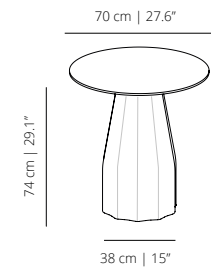

BUD100CNEX
table round 100 | 39³/₈"

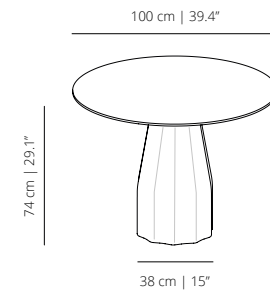

BUC70CNEX
table 70x70 | 27⁶/₁₆" x 27⁶/₁₆"

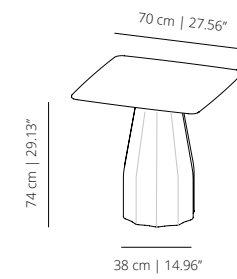

HEIGHT 74 | 29³/₄"

BUC80CNEX
table 80x80 | 31¹/₂" x 31¹/₂"

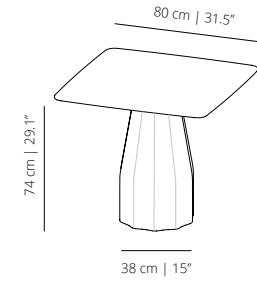

HEIGHT 74 | 29³/₄"

BUC100CNEX
table 100x100 | 39.37" x 39.37"

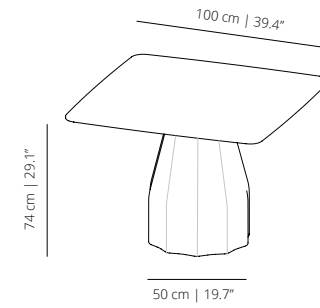

BUC90CNEX
table 90x90 | 35⁷/₁₆" x 35⁷/₁₆"

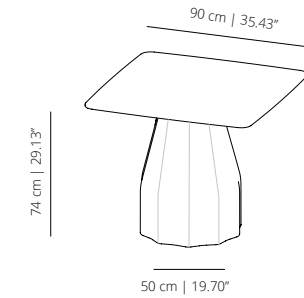

HEIGHT 102 | 40³/₁₆

BUD60HCNEX
table round 60 | 23⁵/₈

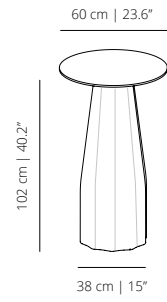

BUD70HCNEX
table round 70 | 27⁵/₁₆

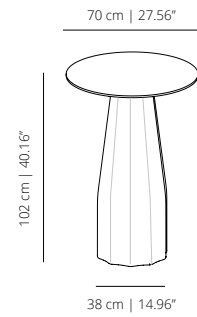

HEIGHT 102 | 40³/₁₆

BUD80HCNEX
table round 80 | 31¹/₂

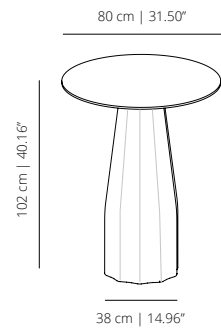

BUD100H
table round 100 | 39³/₈

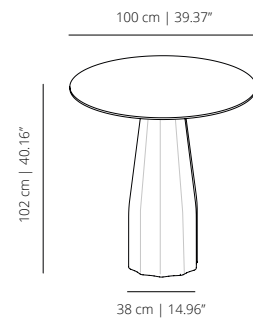

HEIGHT 102 | 40³/₁₆

BUC70HCNEX
table 70x70 | 27⁵/₁₆ x 27⁵/₁₆

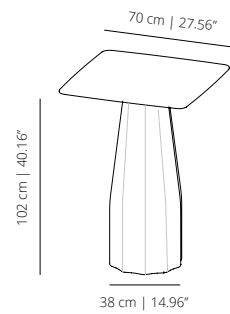

BUC80HCNEX
table 80x80 | 31¹/₂ x 31¹/₂

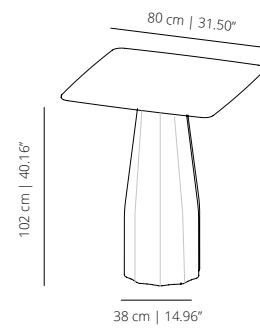

Heights and types of bases available:

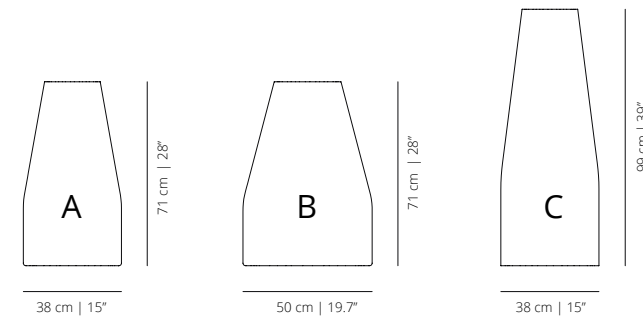

Range of tops for base A: D60 - D100 | 60x60

D23.6" - D39.4" | 23.6"x23.6"

Range of tops for base B: D120 - D150 | 90x90 - 100x100

D47.2" | 35.4"x 35.4" - 39.4"x39.4"

Range of tops for base C: D60 - D100 | 70x70 - 80x80

D23.6" - D39.4" | 27.6"x27.6" - 31.5"x 31.5"

FINISHES

TABLETOPS MATERIALS

Compact

12 mm thick compact laminated table top. The edge can be in black or white. With a black edge, the surface of the tabletop can be black or white; for a white edge, it can be white.



12 mm



black

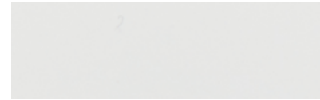

white

BASE OPTIONS

Central support available in roto-moulded polyethylene in white, black or taupe.



white
RAL 9003



black
RAL 9005



taupe
RAL 1019

NOTE: Outdoor cover available to protect the product from water, humidity and sunlight.

SEATING CAPACITY

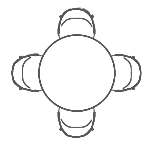

Up to 4

D60 - D100 cm | D23.6" - D39.4"

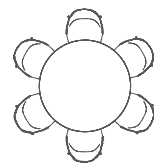

Up to 6

D120 cm | D47.2"

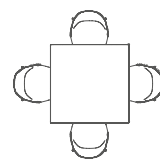

Up to 4

70x70 - 100x100 cm | 27.6x27.6" - 39.4x39.4"

**Seats calculated using Maarten chair, might differ when choosing other models*

ACCESSORIES & ELECTRIFICATIONS



USB hub with battery. USB hub with two USB device charging ports without being plugged into electric current. It's needed to buy the battery charging tray to charge the USB hub battery.



Battery charging tray. Charges up to four stations simultaneously in 7 hours. Includes magnetic key to remove the station from its support

NOTE: Outdoor cover available to protect the product from water, humidity and sunlight.

CERTIFICATIONS

Follows the outdoor regulation: UNE EN 581-2:2016.

Let's talk

We want to help you find the best designs for your project. Contact us and our team will get back to you as soon as possible.

[CONTACT US](#)