

## Assembly instruction 05/2022

### TOOLS:

Allen key SW4 / SW8 (enclosed) / cordless screwdriver

8x countersunk screws M6x16



8x plate head screws M6x16



10x cylinder head screws M8x80

(for table length of 3.4m or longer)

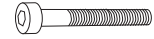

Assemble the table on a **soft surface (e.g. blanket)** to avoid damage.

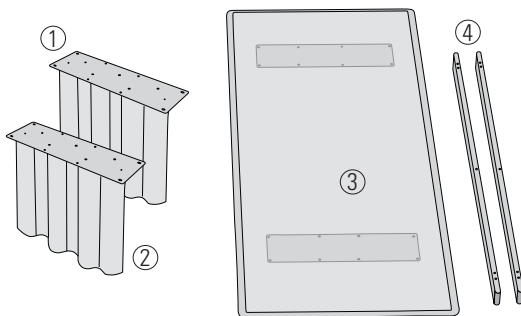

- 1 mounting plates
- 2 leg elements
- 3 tabletop
- 4 support bars (for table length of 3.4m or longer)

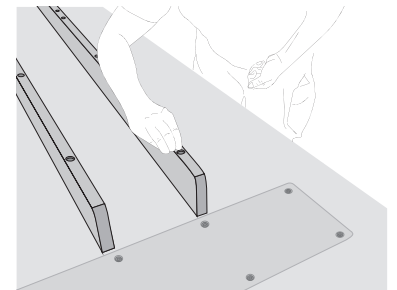
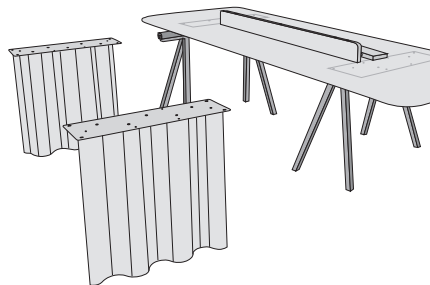
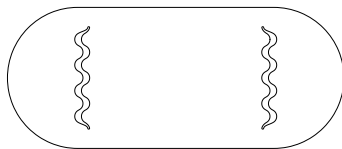

- 1. Assembly recommendation**  
 Rectangular: leg elements facing outwards  
 Semicircle: leg elements facing inwards

- 2. Position the legs.** If necessary, align table with adjustable feet.

- 3. If necessary, mount support bars (4)** on the underside of the tabletop (3) (for table length of 3.4m or longer).

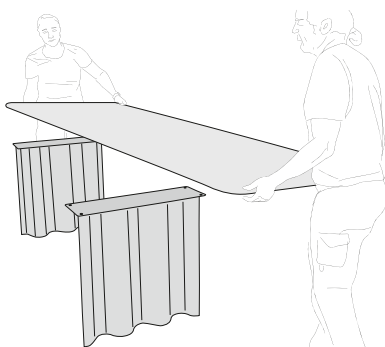

- 4. Position the tabletop on the leg elements** and insert them into the milled pocket.

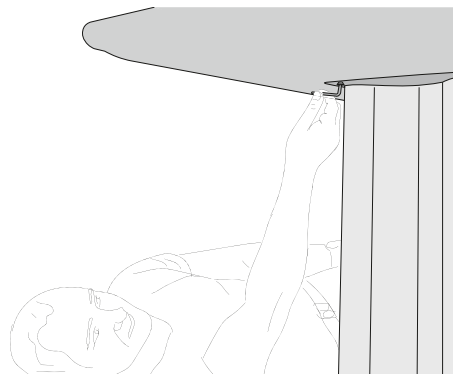

- 5. Screw the leg elements to the tabletop** from below.

**Please note: When assembled move the table only with tension belts (or wooden bars) that are positioned at the metal plates under the tabletop. Otherwise the tabletop may split!**