

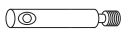



assembly instructions 07/2022

TOOLS:

Allen key SW4 and SW5 (enclosed)

	10 x XS bolts
	10 x connector housings
	10 x grub screws
	16 x confirmat screws 5x50

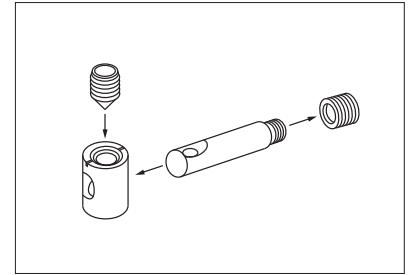

Watch this video for further information on the metal fitting:
<https://www.youtube.com/watch?v=ioLUTDqtvG>

Please assemble the bed **on a soft surface (e.g. a carpet or blanket)** to avoid damages.

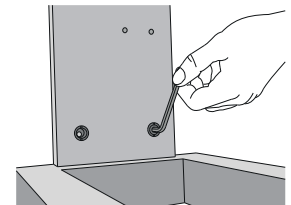
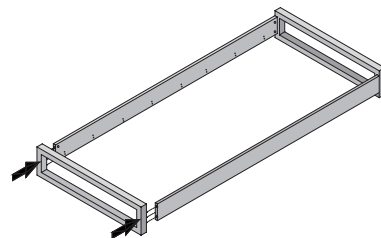
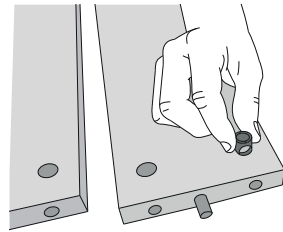
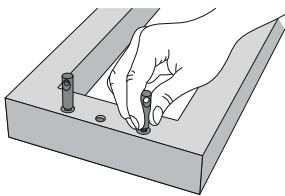

1. Screw XS bolts into foot and head ends and insert the connector housings into the side rails. Align bolts and housings correctly!

2. Join foot and head ends with the side rails. Fix the metal fittings with grub screws.

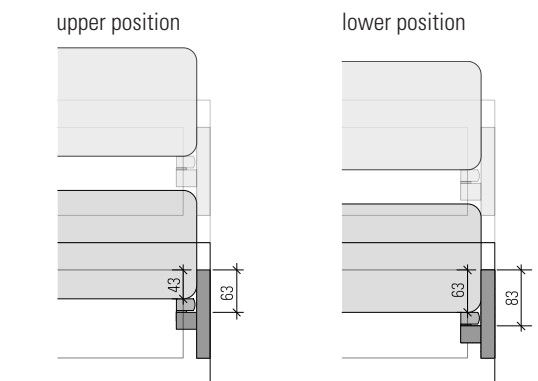
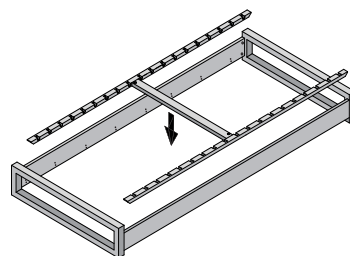
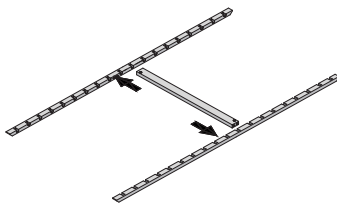

3. Screw XS bolts into the side supports and insert the connector housings into the cross bar. Fit the cross bar between the side supports and tighten the fittings. Place the side supports inside the bed frame.

4. Fix the mattress frame with confirmat screws. We recommend a 5 cm overhang of the mattress. When two GUEST beds are in use, ensure to use the supports at the same height.

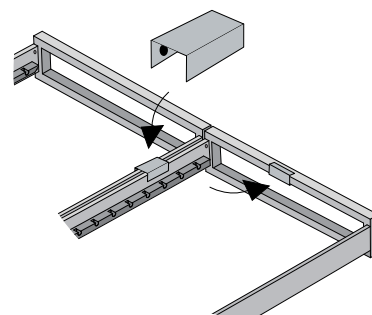
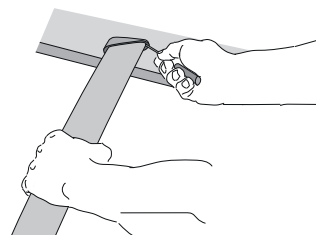
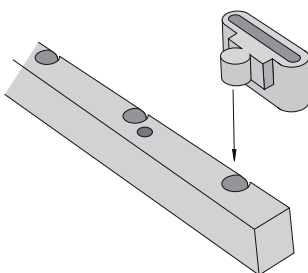

5. Insert the rubber caps into the holes in the mattress supports. Fit the sprung slats into the rubber caps.

6. The GUEST beds can be connected with two aluminium clamps. For this purpose place the beds parallel to each other and join them with the clamps. For non-use please store the clamps upright at the front end of the bed.