

# SIMPLE COMFORT / BUTTON

# ZEITRAUM

## Assembly instructions 07/2022

### TOOLS:

Allen key SW4 und SW5 (enclosed), crosstip screwdriver

8x XS steel bolts

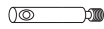

2x countersunk screws (5x60)



8x connector housings



2x countersunk screws (5x80)

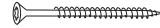

8x grub screws



4x countersunk screws (M8x60)



1x countersunk screw (M8x50)



2x distance blocks

24x confirmat screws

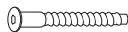

2x center feet (13/17 cm), adjustable

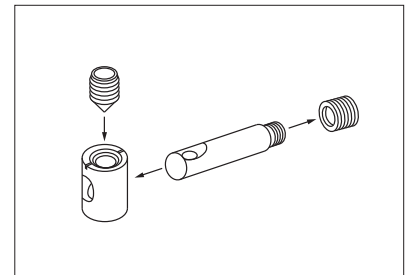

Watch this video for further information on the metal fitting:  
<https://www.youtube.com/watch?v=iolUTDqtvgE>

Please assemble the bed **on a soft surface (e.g. a carpet or blanket)** to avoid damages.

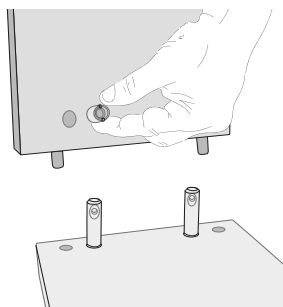

**1.** Screw the bolts into the side rails and insert the connector housing into the head and foot sections. Align bolts and housing correctly!

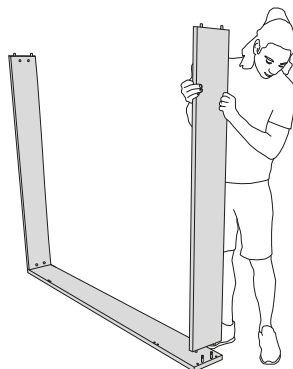

**2.** Attach the head and foot sections to the side rail and fix them with grub screws.

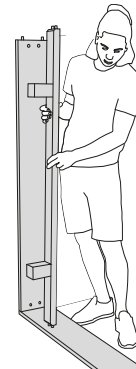

**3.** Attach the bed feet to the crossbars and mount them to the bed side.

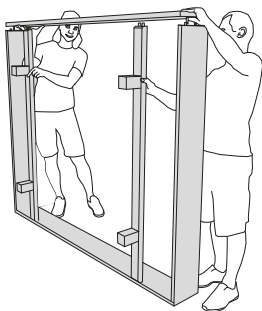

**4.** Connect and fix the second side rail.

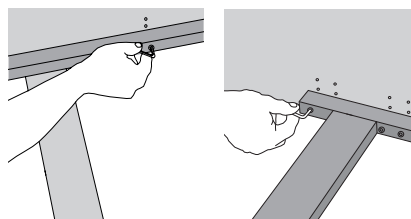

**5.** Fix the side supports using confirmat screws. For mattresses 140 cm or wider, fasten the center rail.

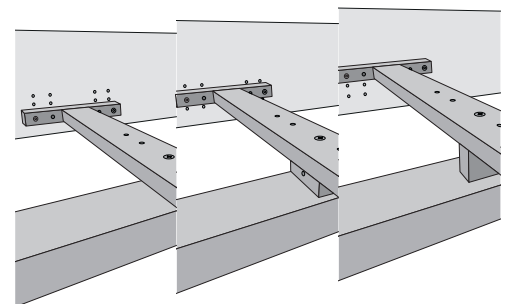

without distance block: insertion depth 14,5 cm  
 horizontal distance block: insertion depth 12,5 cm  
 standing distance block: insertion depth 10,5 cm  
 Use the countersunk screws in the correct length (5x60/80) to fix the distance block.

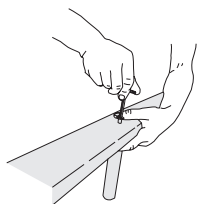

**6.** Choose the correct center feet and connect it to the center rail with the countersunk screw (M8x50). Mind the right length.

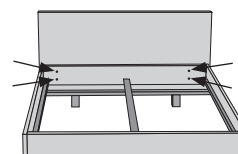
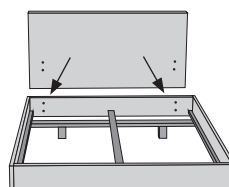

**7.** Position upholstered headboard behind the bed frame. Screw countersunk screws (M8x60) through the frame into the provided holes. Recommendation: At first slightly tighten the four screws. Afterwards screw them in completely.