

assembly instructions 05/2021

TOOLS:

allen key SW4 und SW5 (enclosed), crosstip screwdriver

8x XS bolts



2x countersunk bolts (5x60)



8x connector housing



2x countersunk bolts (5x80)



8x grub screws



2x center feet (13/17 cm), adjustable

1x countersunk bolt (M8x50)



2x distance block

24x confirmat screws

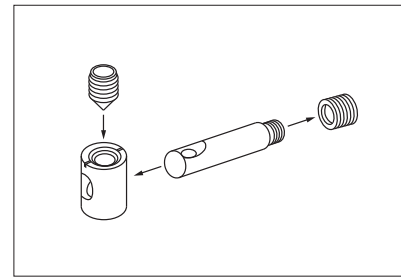

Watch this video for further information on the metal fitting:
<https://www.youtube.com/watch?v=ioIUTDqtvgE>

Please assemble the bed **on a soft surface (e.g. a carpet or blanket)** to avoid damages.

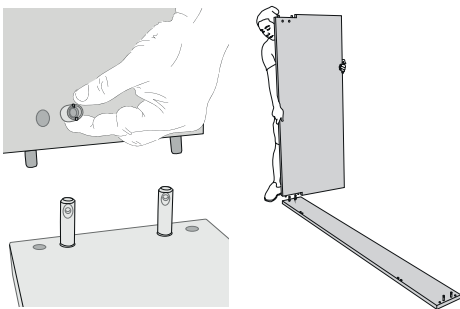

1. Screw the bolts into the long sides and insert the connector housing into the head and foot sections. Align bolts and housing correctly!

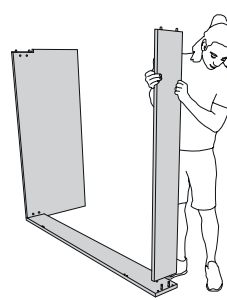

2. Attach the head and foot sections and fix them with grub screws.

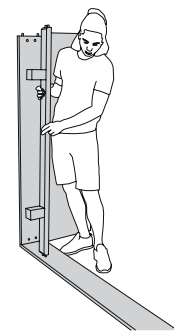

3. Attach the two bed feet to the cross-bars and mount them to the bed side.

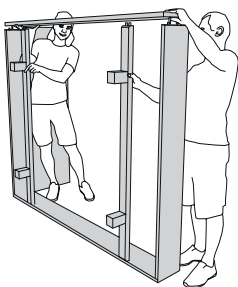

4. Connect and fix the second sidepiece.

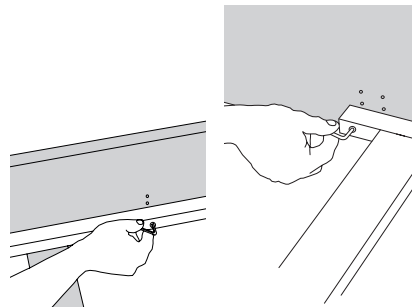

5. Fix the side supports using confirmat screws. For mattresses 140 cm or wider, fasten the center rail.

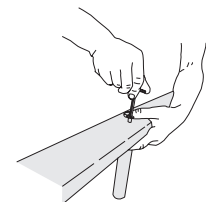

6. Choose the correct center feet and connect it to the center rail with the countersunk screw (M8x50). Mind the right length.

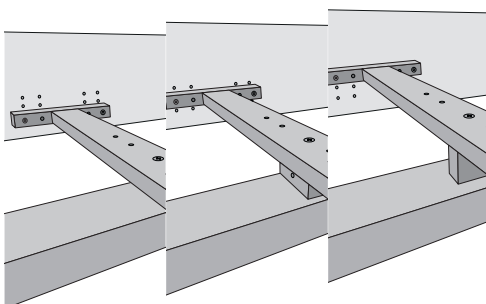

without spacer block: insertion depth 14,5 cm
 horizontal spacer block: insertion depth 12,5 cm
 standing spacer block: insertion depth 10,5 cm
 Use the countersunk screws in the correct length (5x60/80) to fix the spacer block.