

PARASOL PROGRAM



A Cane-line parasol is the perfect way to enjoy your outdoor environment, when the sun is at its highest or the dew comes at night. All parasols from Cane-line are made in contemporary and durable materials, to match any outdoor area, and to maintain its look and function for a long time. The parasols are all manufactured in weather- and UV resistant materials, so the colour will not fade over time, and you can leave it out throughout the summer.

Cane-line®

58240T Classic - short version for Peacock daybed

Design by Cane-line Design

Rope and pulley system



Rope and pulley system

- Nicely detailed and handcrafted teak structure
- Certified teak in grade A from controlled production
- Unique solution dyed fabric
- Washable fabric
- Water repellent
- UVP 50+
- Timeless though classic design
- Functional design with detachable fabric
- In case of damage on the parasol fabric, you have the opportunity to buy a new fabric cover

| MATERIAL | | SIZE/WEIGHT | | | |
|----------------|---|--------------|-------------|--------------|--|
| Parasol pole | Teak frame | Parasol | Dia. 240 cm | Dia. 94.5" | |
| Parasol fabric | Fabric of 100% solution dyed polyester 280gr/m ² | | H 229 cm | H 90.2" | |
| | | | Wgt 15,8 kg | Wgt 34.9 lbs | |
| | | Parasol pole | Dia. 4,8 cm | Dia. 1.9" | |

For covering you parasol use Cover 7 (5650S)

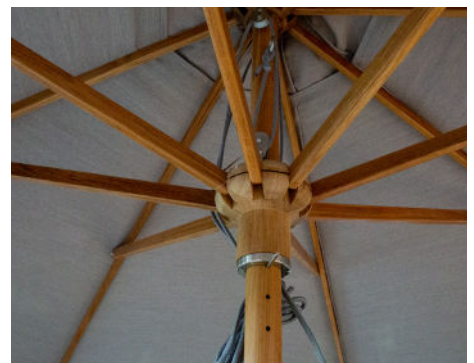

59240T Classic

Design by Cane-line Design

Rope and pulley system



Rope and pulley system

- Nicely detailed and handcrafted teak structure
- Certified teak in grade A from controlled production
- Unique solution dyed fabric
- Washable fabric
- Water repellent
- UVP 50+
- Timeless though classic design
- Functional design with detachable fabric
- In case of damage on the parasol fabric, you have the opportunity to buy a new fabric cover

| MATERIAL | | SIZE/ WEIGHT | | | |
|----------------|---|-----------------|-------------|--------------|--|
| Parasol pole | Teak frame | Parasol | Dia. 240 cm | Dia. 94.5" | |
| | | | H 249 cm | H 98" | |
| Parasol fabric | Fabric of 100% solution dyed polyester 280gr/m2 | | Wgt 16,4 kg | Wgt 36.2 lbs | |
| | | Parasol pole | Dia. 4,8 cm | Dia. 1.9" | |

For covering you parasol use Cover 7 (5650S)

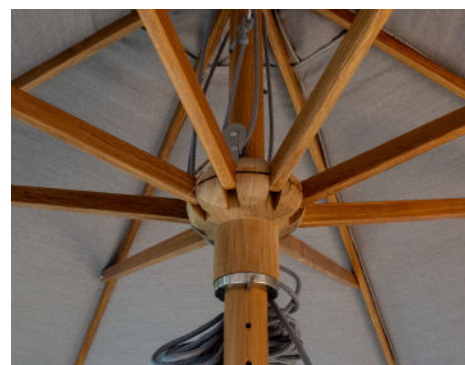

59300T Classic

Design by Cane-line Design

Rope and pulley system



- Nicely detailed and handcrafted teak structure
- Certified teak in grade A from controlled production
- Unique solution dyed fabric
- Washable fabric
- Water repellent
- UVP 50+
- Timeless though classic design
- Functional design with detachable fabric
- In case of damage on the parasol fabric, you have the opportunity to buy a new fabric cover

| MATERIAL | |
|----------------|---|
| Parasol pole | Teak frame |
| Parasol fabric | Fabric of 100% solution dyed polyester 280gr/m2 |
| UV | UVP 50+ |

| SIZE/ WEIGHT | | | | |
|-----------------|------|---------|------|----------|
| Parasol | Dia. | 300 cm | Dia. | 118.1" |
| | H | 249 cm | H | 98" |
| | Wgt | 16,4 kg | Wgt | 36,2 lbs |
| Parasol pole | Dia. | 4,8 cm | Dia. | 1.9" |

For covering you parasol use Cover 7 (5650S)

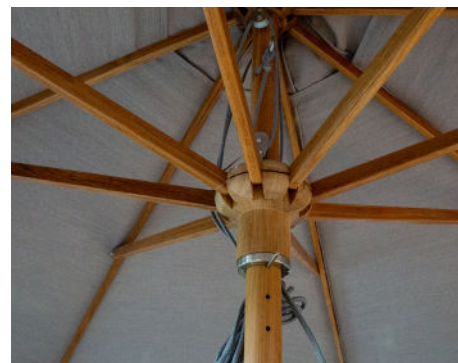

51200X200 Harbour

Design by Cane-line Design

Rope and pulley system

- Strong and durable aluminium pole and center construction
- Unique UV resistant fabric
- UVP 50+
- Detachable washable fabric
- Fit for server contract use
- In case of damage on the parasol fabric, you have the opportunity to buy a new fabric cover



| MATERIAL | |
|----------------|---|
| Parasol pole | Aluminium frame, light grey pole |
| Parasol fabric | Fabric of 100% solution dyed polyester 305gr/m2 |
| UV | UVP 50+ |

| SIZE/ WEIGHT | | | | | |
|-----------------|------|--------|------|----------|--|
| Parasol | W | 200 cm | Dia. | 78.7" | |
| | D | 200 cm | W | 78.7" | |
| | H | 262 cm | H | 103.2" | |
| | Wgt | 8,5 kg | Wgt | 18,8 lbs | |
| Parasol pole | Dia. | 4,8 cm | Dia. | 1.9" | |

For covering you parasol use Cover 7 (5650S)

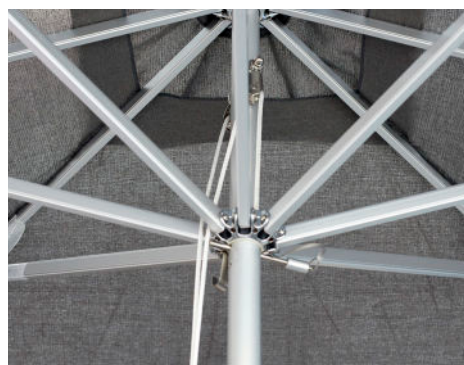

51300X300 Harbour

Design by Cane-line Design

Rope and pulley system

- Strong and durable aluminium pole and center construction
- Unique UV resistant fabric
- UVP 50+
- Detachable washable fabric
- Fit for server contract use
- In case of damage on the parasol fabric, you have the opportunity to buy a new fabric cover



Rope and pulley system

Y505 Anthracite colour



Y504 Dusty white colour

| MATERIAL | |
|----------------|---|
| Parasol pole | Aluminium frame, light grey pole |
| Parasol fabric | Fabric of 100% solution dyed polyester 305gr/m2 |
| UV | UVP 50+ |

| SIZE/WEIGHT | | | | | |
|--------------|------|---------|------|----------|--|
| Parasol | W | 300 cm | Dia. | 118.1" | |
| | D | 300 cm | W | 118.1" | |
| | H | 262 cm | H | 103.2" | |
| | Wgt | 15,2 kg | Wgt | 33,6 lbs | |
| Parasol pole | Dia. | 4,8 cm | Dia. | 1.9" | |

For covering you parasol use Cover 7 (5650S)



583X3 Hyde luxe tilt

Design by Cane-line Design

Hanging parasol with tilt function



360° rotating / Handle for operating

- Strong aluminium pole construction
- UV resistant fabric
- UVP 50+
- Washable detachable fabric
- Cantilever function – allows for space optimization
- Tilt function vertically and horizontally – with dynamic shadow effect
- 360 degree turnable
- In case of damage on the parasol fabric, you have the opportunity to buy a new fabric cover



Y506 Light grey colour



Y507 Taupe colour

Y505 Anthracite colour

| MATERIAL | |
|----------------|--|
| Parasol pole | Aluminium frame, anthracite pole |
| Parasol base | Parasol base purchased separately. Choose between ceramic tiles (4xtiles) or base w/ wheels. |
| Parasol fabric | Fabric of 100% solution dyed polyester 280gr/m2 |
| UV | UVP 50+ |

| SIZE/ WEIGHT | | | | | |
|-----------------|-----|---------|------|----------|--|
| Parasol | W | 300 cm | Dia. | 118.1" | |
| | D | 300 cm | W | 118.1" | |
| | H | 270 cm | H | 103.2" | |
| | Wgt | 25,3 kg | Wgt | 55,8 lbs | |
| Parasol pole | W | 5,8 cm | D | 2.3" | |
| | D | 8,8 cm | W | 3.5" | |

For covering you parasol use Cover 9 (5651S)



See the function on our YouTube channel: www.youtube.com/watch?v=OgWnKH4eSI

58MA3X3 Hyde luxe tilt

Design by Cane-line Design

Hanging parasol with tilt function

- Strong aluminium pole construction
- UV resistant fabric
- UVP 50+
- Washable detachable fabric
- Cantilever function – allows for space optimization
- Tilt function vertically and horizontally – with dynamic shadow effect
- 360 degree turnable
- In case of damage on the parasol fabric, you have the opportunity to buy a new fabric cover



360° rotating / Handle for operating

Y504 Dusty white colour

| MATERIAL | | SIZE/WEIGHT | | | | |
|----------------|---|--------------|-----|---------|------|----------|
| Parasol pole | Aluminium frame, Mat Anodized pole | Parasol | W | 300 cm | Dia. | 118.1" |
| Parasol base | Parasol base purchased separately. Choose between ceramic tiles (4xtiles) or base w/wheels. | | D | 300 cm | W | 118.1" |
| Parasol fabric | Fabric of 100% solution dyed polyester 280gr/m2 | | H | 270 cm | H | 106.2" |
| UV | UVP 50+ | | Wgt | 25,5 kg | Wgt | 55,8 lbs |
| | | Parasol pole | W | 5,8 cm | W | 2.3" |
| | | | D | 8,8 cm | D | 3.5" |

For covering you parasol use Cover 9 (5651S)



See the function on our YouTube channel: www.youtube.com/watch?v=OgWnKHi4eSI

583X4 Hyde luxe

Design by Cane-line Design

Hanging parasol

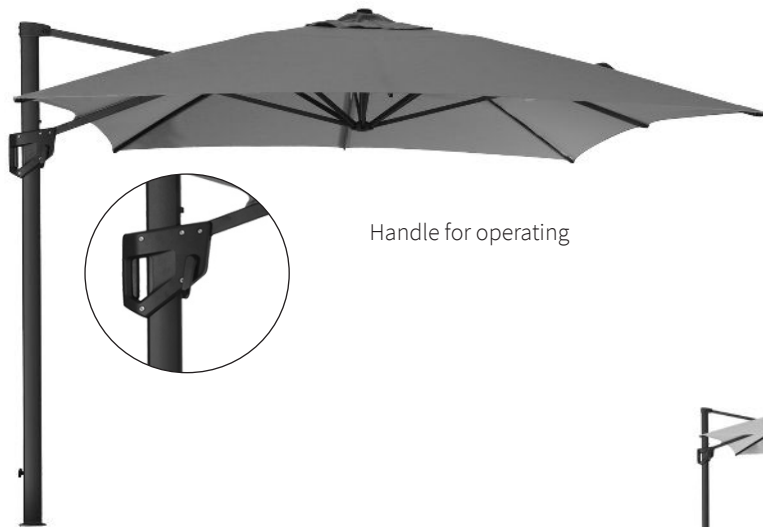

Handle for operating

- Strong aluminium pole construction
- UV resistant fabric
- UVP 50+
- Washable detachable fabric
- Cantilever function – allows for space optimization
- 360 degree turnable
- In case of damage on the parasol fabric, you have the opportunity to buy a new fabric cover



Y506 Light grey colour



Y507 Taupe colour

Y505 Anthracite colour

| MATERIAL | |
|----------------|---|
| Parasol pole | Aluminium frame, anthracite pole |
| Parasol base | Parasol base purchased separately. Choose between ceramic tiles (4xtiles) or base w/wheels. |
| Parasol fabric | Fabric of 100% solution dyed polyester 280gr/m2 |
| UV | UVP 50+ |

| SIZE/WEIGHT | | | | | |
|--------------|-----|---------|------|----------|--|
| Parasol | W | 300 cm | Dia. | 118.1" | |
| | D | 400 cm | W | 157.5" | |
| | H | 278 cm | H | 109.5" | |
| | Wgt | 25,2 kg | Wgt | 55,6 lbs | |
| Parasol pole | W | 5,8 cm | W | 2.3" | |
| | D | 8,8 cm | D | 3.5" | |

For covering you parasol use Cover 18 (5652S)



58MA3X4 Hyde luxe

Design by Cane-line Design

Hanging parasol

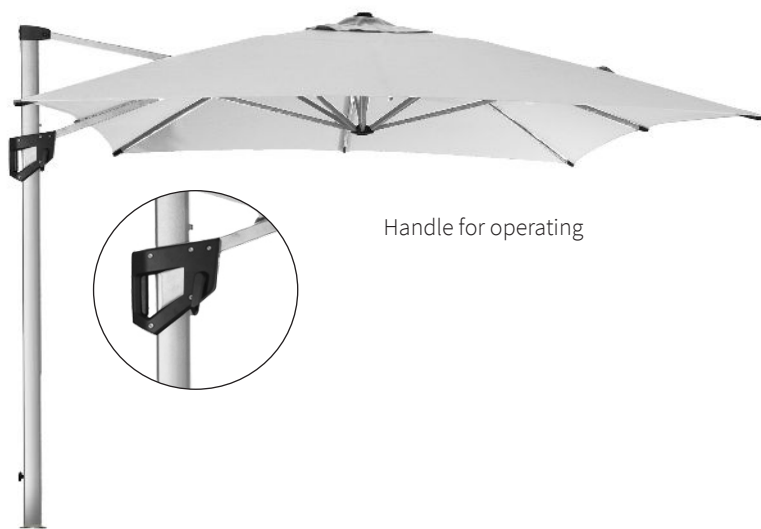

- Strong aluminium pole construction
- UV resistant fabric
- UVP 50+
- Washable detachable fabric
- Cantilever function – allows for space optimization
- 360 degree turnable
- In case of damage on the parasol fabric, you have the opportunity to buy a new fabric cover

Y504 Dusty white colour

| MATERIAL | |
|----------------|---|
| Parasol pole | Aluminium frame, Mat Anodized pole |
| Parasol base | Parasol base purchased separately. Choose between ceramic tiles (4xtiles) or base w/wheels. |
| Parasol fabric | Fabric of 100% solution dyed polyester 280gr/m2 |
| UV | UVP 50+ |

| SIZE/ WEIGHT | | | | | |
|-----------------|-----|---------|------|----------|--|
| Parasol | W | 300 cm | Dia. | 118.1" | |
| | D | 400 cm | W | 157.5" | |
| | H | 278 cm | H | 109.5" | |
| | Wgt | 25,2 kg | Wgt | 55,6 lbs | |
| Parasol pole | W | 5,8 cm | W | 2.3" | |
| | D | 8,8 cm | D | 3.5" | |

For covering you parasol use Cover 18 (5652S)



52300X300 Major

Design by Cane-line Design

Ergonomic sliding system



Ergonomic sliding system

- Anodized aluminium pole
- Ease of use easy to operate – one touch mechanism
- Aluminium pole
- Detachable and washable fabric
- UV resistant fabric UVP 50+
- Water repellent solution dyed fabric
- In case of damage on the parasol fabric, you have the opportunity to buy a new fabric cover



Y505 Anthracite colour

Y506 Light grey colour

| MATERIAL | |
|----------------|---|
| Parasol pole | Aluminium frame, light grey pole |
| Parasol fabric | Fabric of 100% solution dyed polyester 280gr/m2 |
| UV | UPF 50+ |

| SIZE/WEIGHT | | | | | |
|--------------|------|--------|------|-----------|--|
| Parasol | W | 300 cm | Dia. | 118.1" | |
| | D | 300 cm | W | 118.1" | |
| | H | 284 cm | H | 111.9" | |
| | Wgt | 6 kg | Wgt | 13.23 lbs | |
| Parasol pole | Dia. | 4,8 cm | Dia. | 1.9" | |

For covering you parasol use Cover 9 (5651S)



See the function on our YouTube channel: www.youtube.com/watch?v=P2L-QwWSf3A

58MA300 Sunshade

Design by Cane-line Design

Crank system



Y504 Dusty white colour

- Practical function – easy to operate
- Unique crank function
- UV resistant fabric UVP 50+
- Anodized aluminium pole
- In case of damage on the parasol fabric, you have the opportunity to buy a new fabric cover



Y505 Anthracite colour



Y506 Light grey colour

| MATERIAL | |
|----------------|---|
| Parasol pole | Aluminium frame, Mat Anodized pole |
| Parasol fabric | Fabric of 100% solution dyed polyester 280gr/m2 |
| UV | UPF 50+ |

| SIZE/ WEIGHT | | | | | |
|-----------------|------|--------|------|----------|--|
| Parasol | Dia. | 300 cm | Dia. | 118.1" | |
| | H | 247 cm | H | 97.3" | |
| | Wgt | 6,2 kg | Wgt | 13,7 lbs | |
| Parasol pole | Dia. | 4,8 cm | Dia. | 1.9" | |

For covering you parasol use Cover 7 (5650S)



58MATILT300 Sunshade

Design by Cane-line Design

Tilt function

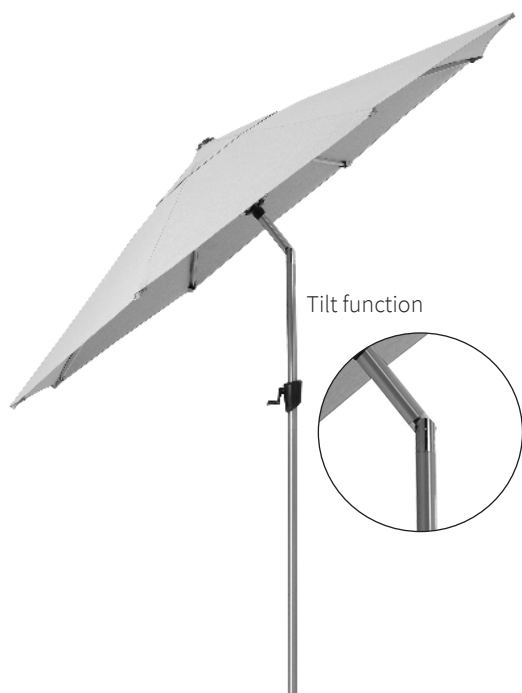

Y505 Anthracite colour

- Practical function – easy to operate
- Unique crank function
- UV resistant fabric UVP 50+
- Anodized aluminium pole
- Tilt function
- In case of damage on the parasol fabric, you have the opportunity to buy a new fabric cover



Y505 Anthracite colour



Y506 Light grey colour

| MATERIAL | |
|----------------|---|
| Parasol pole | Aluminium frame, Mat Anodized |
| Parasol fabric | Fabric of 100% solution dyed polyester 280gr/m2 |
| UV | UPF 50+ |

| SIZE/WEIGHT | | | | | |
|--------------|------|--------|------|----------|--|
| Parasol | Dia. | 300 cm | Dia. | 118.1" | |
| | H | 247 cm | H | 97.3" | |
| | Wgt | 6,2 kg | Wgt | 13,7 lbs | |
| Parasol pole | Dia. | 4,8 cm | Dia. | 1.9" | |

For covering you parasol use Cover 7 (5650S)



53300X300 Shadow

Design by Cane-line Design

Rope and pulley system

- Anodized aluminium
- UV resistant fabric UVP 50+
- Flexible dynamic glasfiber roof construction
- Wind adaptable – less wind sensitive
- In case of damage on the parasol fabric, you have the opportunity to buy a new fabric cover



Rope and pulley system

Y505 Anthracite colour



Y504 Dusty white colour

| MATERIAL | |
|----------------|---|
| Parasol pole | Aluminium frame, light grey pole |
| Parasol fabric | Fabric of 100% solution dyed polyester 305gr/m2 |
| UV | UPF 50+ |
| Parasol ribs | Fiberglass ribs |

| SIZE/WEIGHT | | | | | |
|--------------|------|--------|------|----------|--|
| Parasol | W | 300 cm | W | 118.1" | |
| | D | 300 cm | D | 118.1" | |
| | H | 262 cm | H | 103.2" | |
| | Wgt | 8,5 kg | Wgt | 18.8 lbs | |
| Parasol pole | Dia. | 4,8 cm | Dia. | 1.9" | |

For covering you parasol use Cover 7 (5650S)



5715SC Parasol base

Design by Cane-line Design

With wheels

- Concrete slade construction
- Easy to clean and maintain
- Adjustable pole diameter mechanism
- Integrated castors – easy to move
- Height adjustable



SC Slate

| MATERIAL | | SIZE/ WEIGHT | | | | | | | | |
|--------------|-------|-----------------|-------------|-----------|---------|---------|---------|---------|-----------|-------------|
| Parasol base | Slate | Parasol | W 54 cm | W 21.3" | D 54 cm | D 21.3" | H 40 cm | H 15.7" | Wgt 47 kg | Wgt 103 lbs |
| | | Parasol pole | Dia. 5,4 cm | Dia. 2.1" | | | | | | |

The parasol base comes with adjustable feet.



5718GR Parasol base

Design by Cane-line Design

With wheels

- Granite construction
- Easy to clean and maintain
- Adjustable pole diameter mechanism
- Integrated castors – easy to move



GR Matt grey

| MATERIAL | | SIZE/ WEIGHT | | | | | | | | | | |
|--------------|---------|-----------------|-------------|---------|-----------|-----------|-------------|-----------|-------------|-------------|-------------|-----------|
| Parasol base | Granite | Parasol | W 45 cm | W 17.1" | D 45 cm | D 17.1" | H 46 cm | H 18.1" | Wgt 47 kg | Wgt 103 lbs | | |
| | | Parasol pole | Dia. 5,2 cm | Dia. 2" | Dia. 5 cm | Dia. 1.9" | Dia. 4,8 cm | Dia. 1.8" | Dia. 3,8 cm | Dia. 1.5" | Dia. 3,2 cm | Dia. 1.3" |

The parasol base comes with adjustable feet.



5779 Grow parasol base

Design by Cane-line Design

With wheels

- Weather resistant powder coated aluminium
- Functional hybrid product – which works as a planter as well
- Integrated castors
- Adjustable pole diameter mechanism



ALI Lava grey/Light grey

| MATERIAL | | SIZE/ WEIGHT | | | | | | | | |
|--------------|-----------|-----------------|-------------|-----------|--------------------|-------------|-----------|---------------------|------------|--------------|
| Parasol base | Aluminium | Parasol | W 50 cm | W 19.7" | D 50 cm | D 19.7" | H 48 cm | H 18.9" | Wgt 9,7 kg | Wgt 21.5 lbs |
| | | Parasol pole | Dia. 5,4 cm | Dia. 2.1" | For bigger parasol | Dia. 4,8 cm | Dia. 1.9" | For smaller parasol | | |

Remember to add a drain and potting compost to the base to ensure that the parasol is stable.



5719GR Hyde luxe parasol base

Design by Cane-line Design

With wheels

- Granite construction
- Easy to clean and maintain
- Integrated castors – easy to move
- Parasol base with lockable wheels
- Easy to move and lock system ensuring that the parasol is not being pushed out of the desired location by the wind



GR Matt grey

| MATERIAL | | SIZE/ WEIGHT | | | | |
|--------------|---------|-----------------|-----|--------|-----|---------|
| Parasol base | Granite | Parasol | W | 75 cm | W | 29.5" |
| | | | D | 75 cm | D | 29.5" |
| | | | H | 7,5 cm | H | 3.1" |
| | | | Wgt | 100 kg | Wgt | 220 lbs |



5717TG (1 tiles) Hyde luxe parasol base, 4 tiles

Design by Cane-line Design



TG Grey

| MATERIAL | | SIZE/ WEIGHT | | | | |
|--------------|----------|-----------------|-----|-------|-----|--------|
| Parasol base | Concrete | Parasol | W | 50 cm | W | 19.7" |
| | | | D | 50 cm | D | 19.7" |
| | | | H | 5 cm | H | 2" |
| | | | Wgt | 25 kg | Wgt | 55 lbs |

